

Brand, Model	Device: FMB140 LV-CAN	Year:	Rev.:
VW T-ROC (A1) (Start-button)		2022→	13
Version: with and without Keyless System		program №: 14278 from: 2023-05-22	

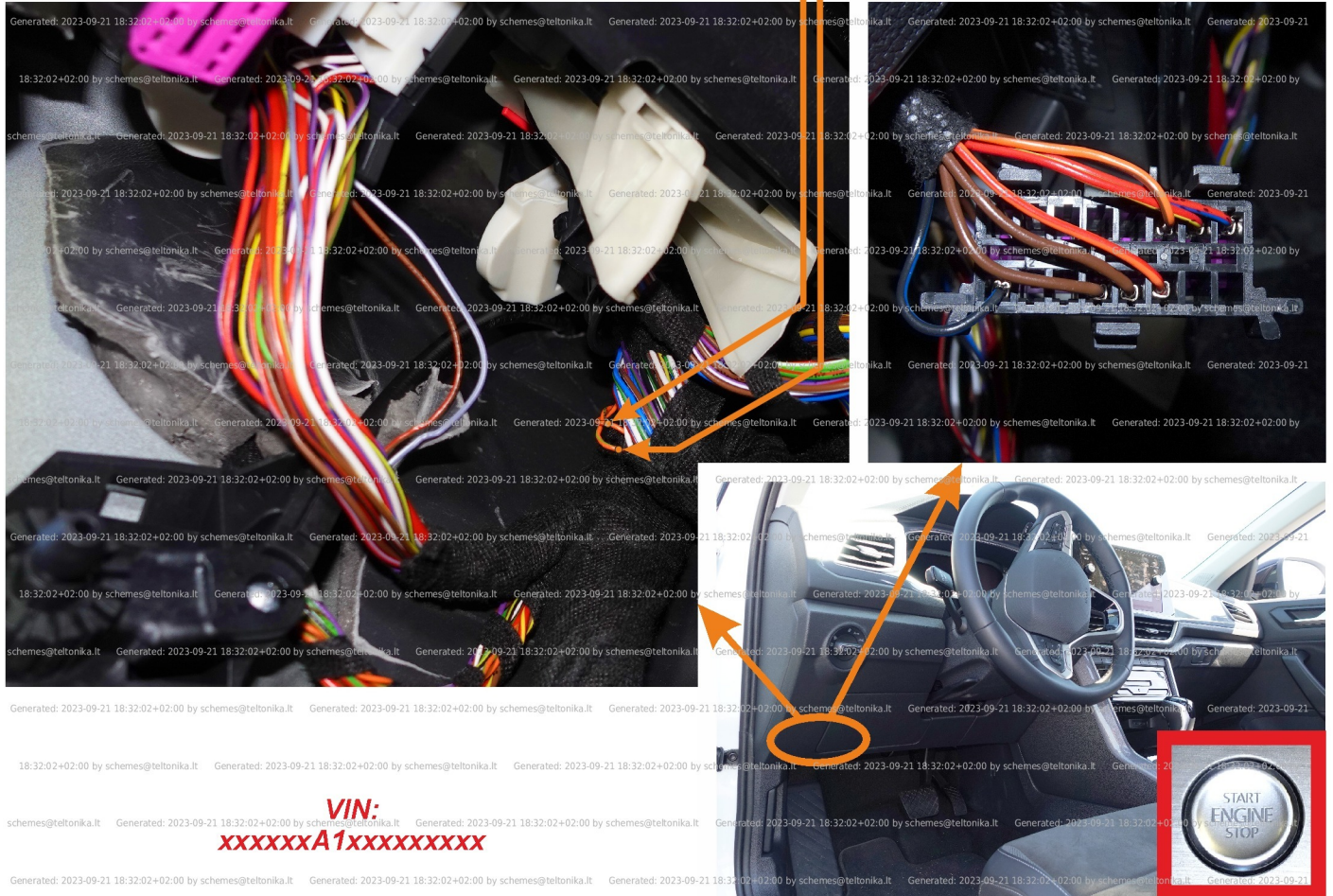

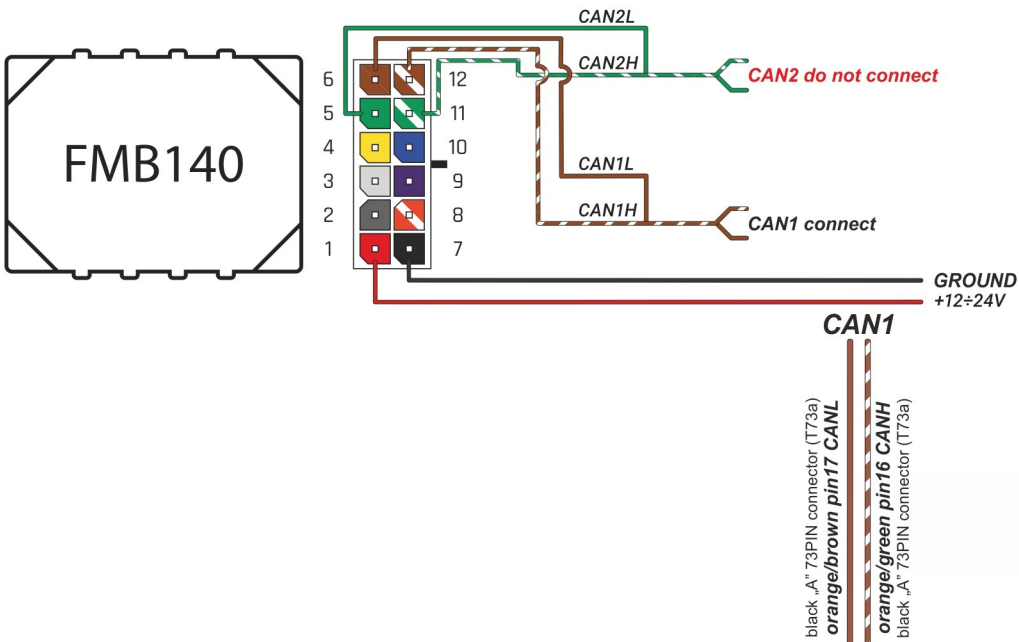







VIN:
xxxxxxA1xxxxxxxx



Start-button only

Flags:

- | | | | |
|---|---|---|--|
|  Ignition |  Front left door |  Front right door |  Rear left door |
|  Rear right door |  Trunk cover |  Engine cover (Hood) |  Oil pressure / level |
|  Washer fluid level indicator turned on | | | |

General parameters:

- | | | |
|--|-------------------------------|--------------------------------------|
| ● Total mileage of the vehicle (dashboard) | ● Vehicle mileage - (counted) | ● Total fuel consumption - (counted) |
| ● Fuel level (in liters) | ● Engine speed (RPM) | ● Engine temperature |
| ● Vehicle speed | ● Acceleration pedal position | |