

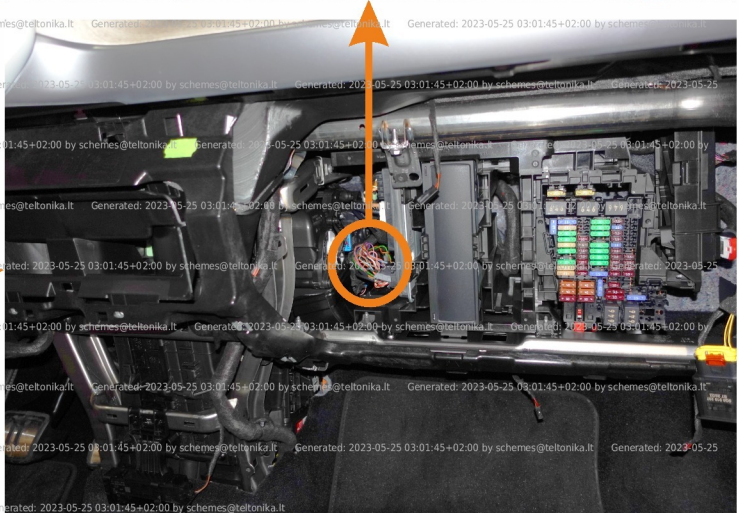

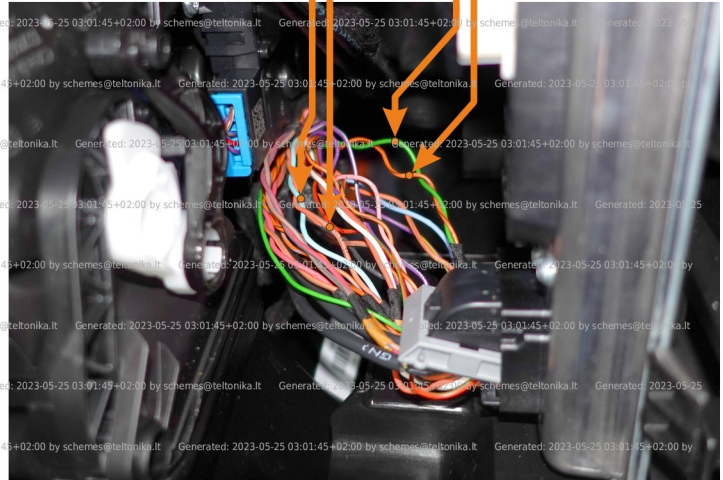

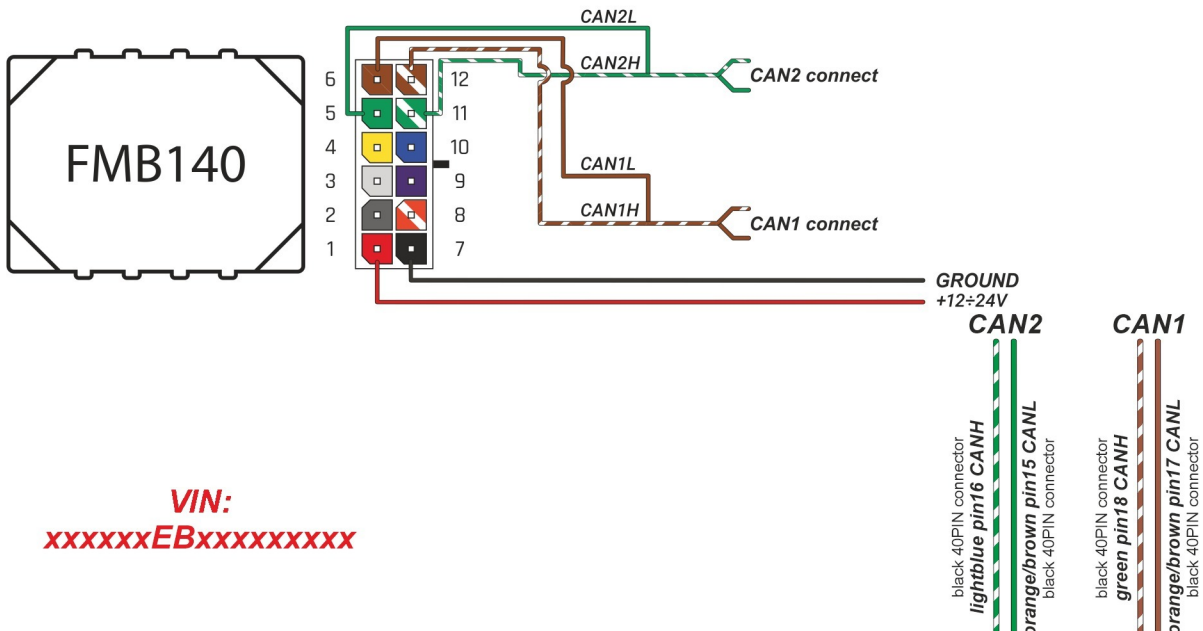





Brand, Model	Device: FMB140 LV-CAN	Year:	Rev.:
VW ID. BUZZ CARGO (EB) (Electric)		2023→	11
Version: with and without Keyless System	program №: 14518 from: 2023-05-22		



Flags:

 Ignition	 Front left door	 Front right door	 Rear right door
 Trunk cover	 Engine cover (Hood)	 Charging cable connected	 HV battery charging
 Electric engine working	 Washer fluid level indicator turned on		

General parameters:

- Total mileage of the vehicle (dashboard)
- Vehicle mileage - (counted)
- Vehicle speed
- Acceleration pedal position
- HV battery level